

Leak Free Shower Cubicles Housebuilder Range

Kinedo



No
~~Silicone~~
Sealant
Required!



stain resistant glass
CristalPlus™



NO silicone NO problems NO leaks
www.kinedo.co.uk

Variations on a theme... putting freedom of choice into

freestyle 2000 CA66 GB



- Option 1 is the Freestyle 2000 complete with a “laminated sandwich” shower panel into which you are able to fit a shower of your choice including electric.



freestyle 2000 thermo CA63



- Option 2 is the Freestyle 2000 Thermo complete with a frosted glass shower panel and a thermostatic shower valve.

The three self contained shower cubicles above are an excellent example of how Kinedo develop products to provide the house builder with the best possible options. All three models share the same doors, panels and shower tray, yet provides ultimate versatility for the housebuilder.

Who are Kinedo?

Kinedo is the showering division of Saniflo Ltd. which is a wholly owned subsidiary of Group SFA of France. Our state of the art factory comprises two sites just outside Nantes in North West France. The two sites have a combined capacity to produce in excess of 300,000 pieces per annum and occupy a total of over 25,000m². Both sites are fully robotised and utilise some of the most up to date modern machinery specific to the manufacture of self contained shower cubicles and shower enclosures. One of the most important reasons for you, as a house builder for dealing with Kinedo, is that you have the confidence in us as a company and of our ability to deliver our promises. With the benefit of a truly global organisation you can be assured that Kinedo is the ideal partner when it comes to “off the shelf” or “customer specific” quality showering products.

o freestyle

freestyle 2000 hydro CH630



- Option 3 is the Freestyle 2000 Hydro complete with a frosted glass shower panel and a factory fitted hydro massage system and a thermostatic shower valve.

Freestyle 2000/Thermo/Hydro additional features

- 4mm toughened safety glass to BS6206 Class A
- Optional teak seat
- Frosted glass shower panel (laminated shower panel only on the CA66 GB)

lagune thermo CA61



Lagune additional features

- 6mm toughened safety glass to BS6206 Class A
- Optional teak seat
- Frosted glass shower panel



Detail of door handle from the inside

Freestyle 2000 & Lagune Technical Specification

Corner Entry 800mm x 800mm x 1980mm for corner fitting
 Pivot door & side panel 800mm x 800mm x 1980mm for corner fitting
 Shock resistant thermo formed panels
 Thermo formed shower tray with polystyrene honeycomb insert
 6mm glass on fixed panels (Freestyle 2000)
 4mm glass on sliding doors (Freestyle 2000)
 6mm pivot door and side panel (Lagune)
 6mm pre drilled frosted glass shower panel

4mm undrilled laminate sandwich panel (CA66GB)
 Thermostatic shower valve (min 1 bar pressure max 5 bar) with 22mm tails
 Optional pre-fitted hydromassage system with 6 body jets and diverter valve (min 2.5 bar pressure required)
 Top access shower tray waste trap supplied
 All glass coated with CristalPlus to reduce lime scale build up
 Optional teak seat

Freestyle 2000 Models Available

CA66 GB Freestyle 2000 (with laminate panel)
 CA63 Freestyle 2000 Thermo (with glass shower panel and thermostatic shower valve)
 CH630 Freestyle 2000 Hydro (with thermostatic shower valve and hydro massage system)

Lagune Models Available

CA61 Lagune Thermo (with glass shower panel and thermostatic shower valve)
 CH610 Lagune Hydro (with thermostatic shower valve and hydro massage system)

opus corner CH260

■ 6mm toughened safety glass to BS6206 Class A



opus quad thermo CA28

■ 4mm toughened safety glass to BS6206 Class A

■ 900 x 900mm



Opus

A family of generously proportioned shower cubicles offering options for most installation requirements. Choose from 900 x 900mm corner/quadrant with sliding doors or 1000 x 800mm with a pivot door. Once again offering the housebuilder ultimate choice and versatility.

opus wall CA105

- 6mm toughened safety glass to BS6206 Class A
- Frosted glass shower panel
- Integral chrome towel rail



Detail of Thermostatic valve control

Technical Specification

- Corner Entry 900mm x 900mm x 2090mm (steam version 2190mm high)
- Quadrant 900mm x 900mm x 2090mm (steam version 2190mm high)
- Opus 1000 x 800 pivot door
- Shock resistant thermo formed panels
- Thermo formed shower tray with polystyrene honeycomb insert
- 6mm glass on corner entry
- 4mm glass on quadrant
- Thermostatic shower valve (min 1 bar pressure max 5 bar) with 22mm tails
- Optional pre-fitted hydromassage system with six body jets & six back jets and diverter valve (min 2.5 bar pressure required)
- Optional pre-fitted 2kw self draining steam system
- Top access shower tray waste trap supplied
- All glass coated with CristalPlus to reduce lime scale build up
- Integral moulded seat (not standard on the wall model)

opus recess CA111

- 6mm toughened safety glass to BS6206 Class A
- Frosted glass shower panel



Models Available

- CA25GB Opus corner entry standard (no shower fittings supplied)
- CA26 Opus corner entry thermo (with thermostatic shower valve)
- CH260 Opus corner entry hydro (with factory fitted hydro massage system)
- CMH260 Opus corner steam (with factory fitted steam system in addition to hydro massage)
- CA27GB Opus quadrant standard (no shower fittings supplied)
- CA28 Opus quadrant thermo (with thermostatic shower valve)
- CH280 Opus quadrant hydro (with factory fitted hydro massage system)
- CMH280 Opus quadrant steam (with factory fitted steam system in addition to hydro massage)
- CA76 Opus 1000 x 800 corner pivot thermo
- CH760 Opus 1000 x 800 corner pivot hydro (with factory fitted hydro massage system)
- CA105 Opus 1000 x 800 pivot thermo. Designed to be fitted against one wall
- CA111 Opus 1000 x 800 pivot thermo. Designed to be fitted in a recess (can be supplied with an undrilled panel for fitting alternative shower valves or electric showers).

Detail of hydromassage jet



kinelux CA17 GB

- 4mm toughened safety glass to BS6206 Class A
- Optional teak seat



Detail showing removable panel



Detail showing adjustable feet and waste

Kinelux recess

The Kinelux 800 x 800mm recess shower cubicle featuring an inward opening bifold door, a height adjustable shower tray with Removable panel. Designed specifically for new build. It can be installed in approximately 90 minutes.

Technical Specification

- 800 x 800mm, 2085mm high
- Thermo formed shower tray with reinforced base board
- 5 adjustable feet
- Removable shower tray panel
- Inward opening bifold door
- 4mm toughened safety glass
- Factory fitted thermostatic shower valve with 22mm tails and 1.5 metre braided hoses

Model Available

CA17 GB Kinelux recess thermo

horus thermo CA47



Two luxuriously proportioned cubicles. Horus: a vast 1160 x 1160mm sliding quadrant including a wood seat. Flotille: a designer bow fronted rectangular cubicle with a sliding door, with optional mirror, seat and deck.

flotille hydro 1BTN V6HT



Horus & Flotille



Detail of top access shower tray waste with removable hair trap. This feature is common to all cubicles.

Technical Specification (Horus)

1160 x 1160mm quadrant with sliding doors
2080mm high
4mm toughened safety glass to BS6206 A
Thermo formed shower tray with polystyrene honeycomb insert
Factory fitted thermostatic shower valve (min 1 bar pressure, max 5 bar) with 22mm tails
Optional pre-fitted hydromassage body jets and six back jets

Technical Specification (Flotille)

1100 x 900mm bow fronted with sliding door
2070mm high
6mm toughened safety glass to BS6206 A
Thermo formed shower tray with polystyrene honeycomb insert
Factory fitted thermostatic shower valve (min 1 bar pressure, max 5 bar) with 22mm tails
Optional pre-fitted hydromassage body jets

Models Available

CA47 Horus quadrant thermo
CH470 Horus quadrant hydro
1BTN V6T Flotille thermo
1BTN V6HT Flotille hydro



Detail showing quick release clips for ease of glass cleaning (Flotille only)



summary



freestyle 2000

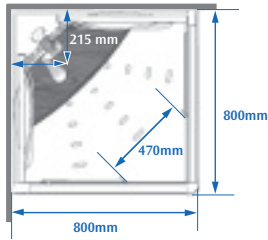

lagune

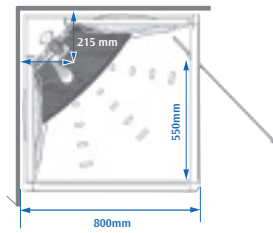

opus corner

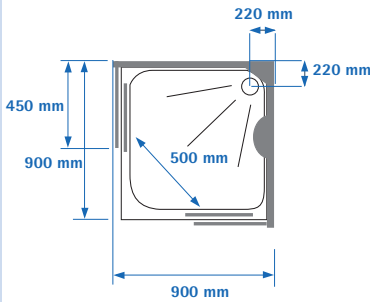

opus quad

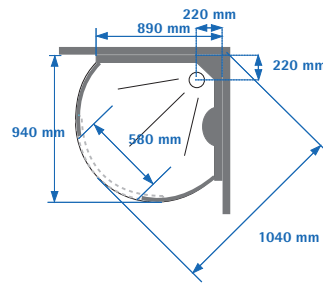

opus corner pivot

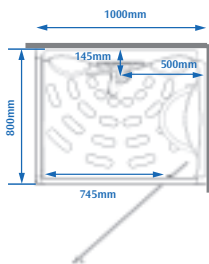

opus wall

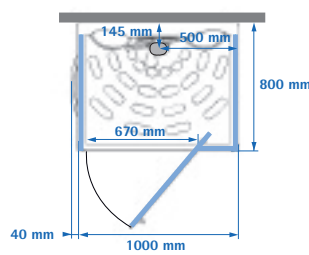

opus recess

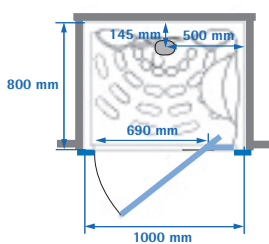

horus

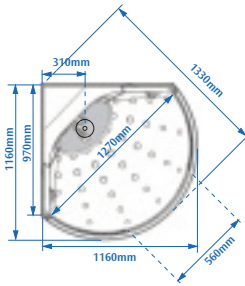

flotille

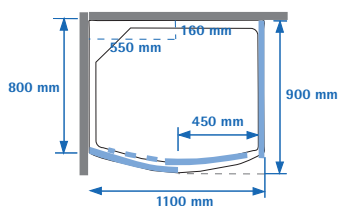

kinelux

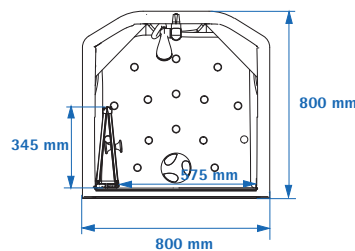

Specifications

Name	Models Available	Footprint Size (mm)	Height (mm)	Door	Wall Position
Freestyle 2000	Adaptable* Thermo Hydro	800 x 800	1980	Slider	Corner
Lagune	Thermo Hydro	800 x 800	1980	Pivot	Corner
Opus Corner	Adaptable* Thermo Hydro Steam	900 x 900	2090 2190 (steam)	Slider	Corner
Opus Quadrant	Adaptable* Thermo Hydro Steam	900 x 900	2090 2190 (steam)	Slider	Corner
Opus Corner Pivot	Thermo Hydro	1000 x 800	2070	Pivot	Corner
Opus Wall	Thermo	1000 x 800	2070	Pivot	One Wall Only
Opus Recess	Adaptable* Thermo	1000 x 800	2070	Pivot	Alcove
Horus	Thermo Hydro	1160x1160 (max)	2080	Slider	Corner
Flotille	Thermo Hydro	1100 x 900	2070	Slider	Corner
Kinelux	Thermo	800 x 800	2080	Inward bifold	Alcove

*No shower supplied. Will accommodate either a shower valve or electric shower.

As part of our commitment to housebuilders we offer product demonstrations as well as on-site installation advice.